



Conform to CE standard

Typical Features

- ◆ Wide input voltage range 2:1
- ◆ High efficiency up to 89%
- ◆ Low no-load power consumption
- ◆ Operating Temperature: -40℃ to +100℃
- ◆ High isolation voltage, input-output 3000VAC, input-case 2000VAC
- ◆ Protection: Input under voltage, output over voltage, short circuit, over current, over temp
- ◆ Standard 1/2 brick

ZBD300-280S28C high efficiency brick dc-dc converter, rated input voltage 280VDC, output 28V/300W, no minimum load, wide input 185-400VDC, regulated single output, high isolation insulation voltage, allowing operating temperature up to 100 ℃, with input under-voltage protection, output over-current, over-voltage, over-temperature, short-circuit protection, remote control and remote compensation, output voltage regulation and other functions.

Typical Product List

Part no	Input voltage range (VDC)	Output power (W)	Output voltage (VDC)	Output current (A)	Ripple & Noise (mV)	Full load efficiency(%) Min/Typ.	Note
ZBD300-280S28CC	185-400	300	28	10.7	280	87/89	Standard positive logic
ZBD300-280S28CN							Standard negative logic
ZBD300-280S28CC-H							Heatsink positive logic
ZBD300-280S28CN-H							Heatsink negative logic

Input Specification

Item	Operating conditions	Min.	Typ.	Max.	Unit
Max input current	185V input voltage, full load output	--	--	2.5	A
No load input current	Rated input voltage	--	--	10	mA
Input surge voltage (1sec. max.)	Inputs above this range may cause permanent damage	-0.7	--	425	VDC
Start up voltage		--	--	180	
Input under voltage protection	No-load test, full-load test will have over current protection in advance	--	--	170	
Control Pin(CNT)	Positive logic: CNT is suspended or connected to 3.5-15V to turn on, connected to 0-1.2V to turn off				Reference voltage-VIN
	Negative logic: CNT is suspended or connected to 3.5-15V to turn off, connected to 0-1.2V to turn on				

Output Specification

Item	Working conditions	Min.	Typ.	Max.	Unit
Output Voltage Accuracy	Nominal input voltage, 0%-100% load	--	±0.2	±2.0	%
Line Regulation	Full load, input voltage from low to high	--	±0.1	±0.2	
Load Regulation	Nominal input voltage, 10%-100% load	--	±0.1	±0.2	
Transient recovery time	25% load step change (step rate 1A/50uS)	--	200	250	uS
Transient Response Deviation		-5	--	5	%
Temperature Drift Coefficient	Full load	-0.02	--	+0.02	%/°C
Ripple & Noise	20M bandwidth, external capacitor above 220uF	--	200	280	mVp-p
Output voltage adjustment (TRIM)		19	--	32	%
Output voltage remote compensation (Sense)		--	--	105	%
Over temp protection	Maximum temperature of product metal substrate surface	105	115	125	°C
Output over voltage protection		33	--	36	%
Output over current protection		105	--	--	A
Output short circuit protection		Hiccup, continuous, self-recovery			

General Specification

Item	Operating conditions		Min.	Typ.	Max.	Unit
Isolation Voltage	I/P-O/P	Test 1min, leakage current < 3mA	3000	--	--	VAC
	I/P-Case	Test 1min, leakage current < 3mA	2000	--	--	VAC
	O/P-Case	Test 1min, leakage current < 3mA	500	--	--	VDC
Insulation resistance	I/P-O/P	Insulation voltage 500VDC	100	--	--	MΩ
Switching frequency			--	250	--	KHz
MTBF			150	--	--	K hours

Environmental characteristics

Item	Operating conditions	Min.	Typ.	Max.	Unit
Operating Temperature	See temperature derating curve	-40	--	+100	°C
Storage Humidity	No condensing	5	--	95	%RH
Storage Temperature		-40	--	+125	°C
Soldering resistance of pins	The solder joint is 1.5mm away from the shell, and the soldering time < 1.5S	--	--	+350	

EMC Characteristics(EN50155)

EMI	CE	EN50121-3-2	150kHz-500kHz 79dBuV	
		EN55016-2-1	500kHz-30MHz 73dBuV	
	RE	EN50121-3-2	30MHz-230MHz 40dBuV/m at 10m	
		EN55016-2-1	230MHz-1GHz 47dBuV/m at 10m	
EMS	ESD	EN50121-3-2	Contact ±6KV/Air ±8KV	perf. Criteria A
	RS	EN50121-3-2	10V/m	perf. Criteria A
	EFT	EN50121-3-2	±2kV 5/50ns 5kHz	perf. Criteria A
	Surge	EN50121-3-2	line to line ± 1KV (42Ω, 0.5μF)	perf. Criteria A
	CE	EN50121-3-2	0.15MHz-80MHz 10 Vr.m.s	perf. Criteria A

Physical Characteristics

Case Materials	Metal bottom shell + black flame retardant material shell (UL94 V-0)
Heat sink	Dimension 61*57.9*15mm, weight 65g, aluminum alloy, anodized black
Cooling method H	Conduction cooling or forced air cooling
Product Weight	Standard 120g, with heatsink 188g

Dimension and Pin-Out

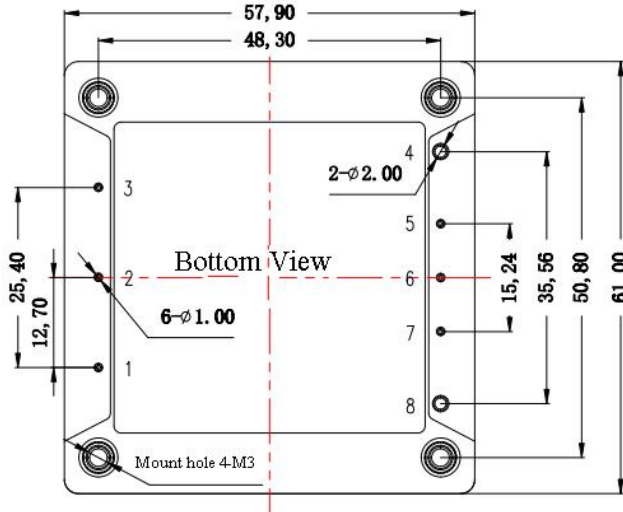

first angle projection

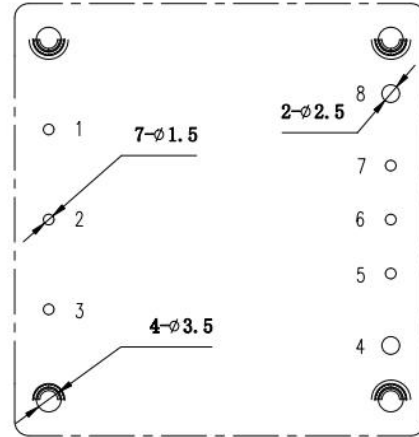

Recommended PCB Slot size

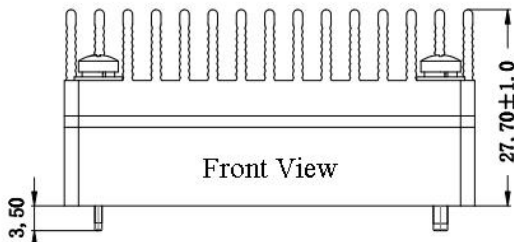

Front View

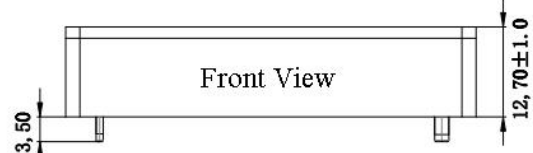

Front View

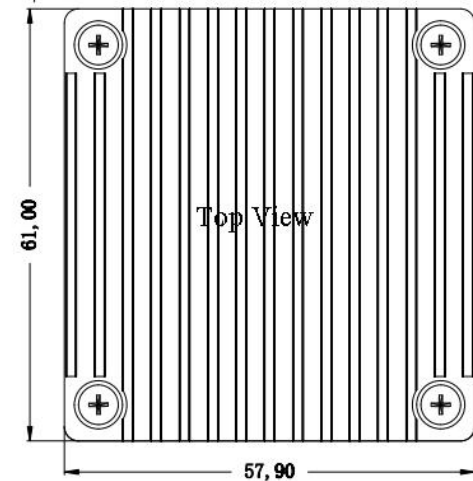

Top View

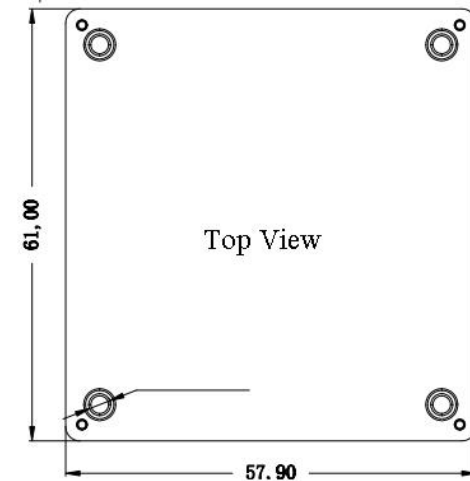

Top View

Standard+Heatsink
61*57.9*27.7mm

Standard
61*57.9*12.7mm

Note:
Unit:mm
Pin 1,2,3,5,6,7 dia:1.00
Pin 4,8 dia:2.00
general tolerance:±0.10
mounting hole tightening torque: Max 0.4N*m

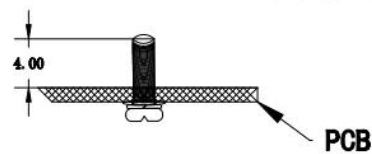

	1	2	3	4	5	6	7	8
Pin-out	Vin+	CNT	Vin-	Vout-	-S	TRIM	+S	Vout+

Product Characteristic Curve

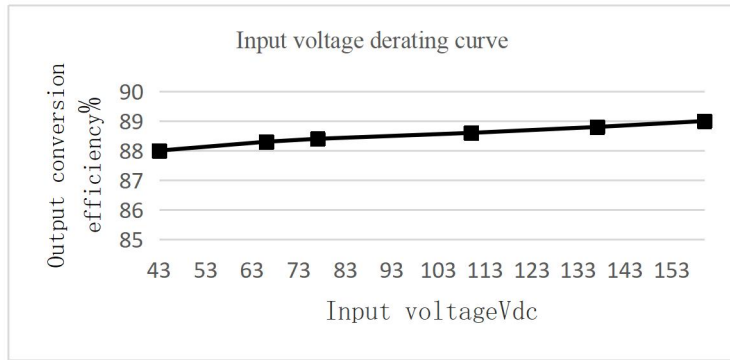
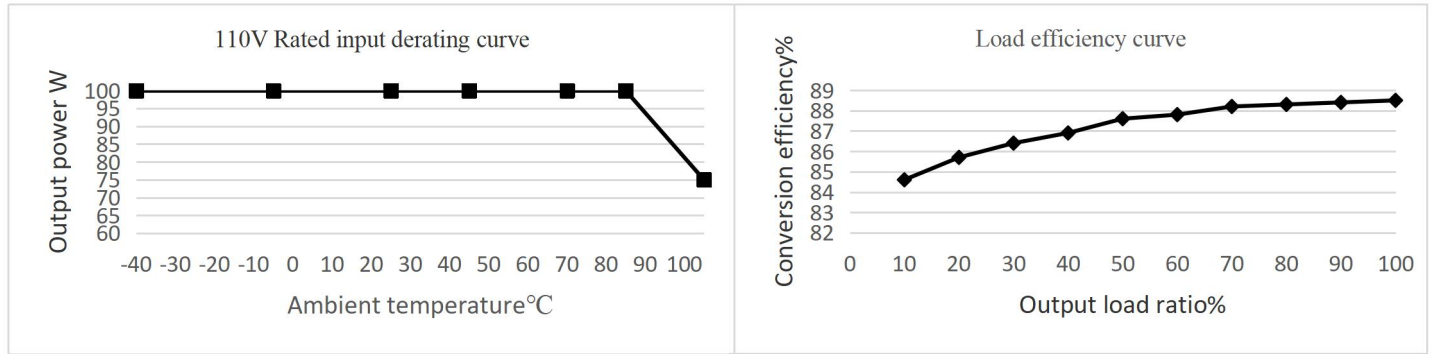

Note:

- Both the temperature derating curve and the efficiency curve are tested with typical values;
- The temperature derating curve is tested according to our laboratory test conditions. If the actual environmental conditions used by customers are inconsistent, it is necessary to ensure that the temperature of the aluminum casing of the product does not exceed 100°C, and it can be used within any rated load range.

Design Reference

1. Ripple & Noise

All DC/DC converters of this series are tested according to the test circuit recommended in the following figure before leaving the factory.

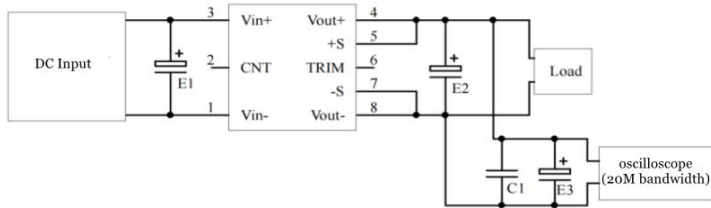

capacitor value	E1 (μF)	E2 (μF)	C1 (μF)	E3 (μF)
Output voltage				
3.3VDC	100	1000	1	10
5VDC		680		
12VDC		220		
.....				
48VDC				
.....				
110VDC	68	68		

2. Recommended application circuit

If customer does not use the circuit recommended by our company, please be sure to connect an electrolytic capacitor of at least 100 μF in parallel at the input end to suppress the possible surge voltage at the input end.

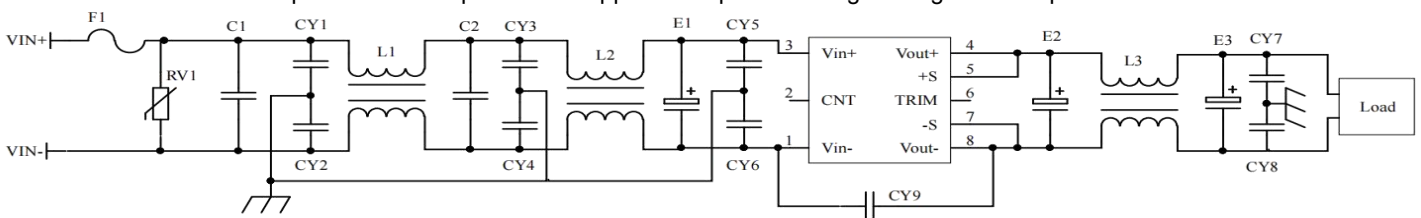

F1	T10A/250Vac fusing
RV1	14D 560V Varistor
C1,C2	105/450V Polyester Film Capacitor
CY1,CY2,CY3,CY4,CY5,CY6	472/250Vac safety Y2 capacitor
CY7,CY8	103/2KV Ceramic Capacitor
CY9	471/250Vac safety Y2 capacitor
E1	100μF/450V Electrolytic Capacitor
E2, E3	220μF/35V Electrolytic Capacitor
L1,L2	inductance is greater than 10mH, and the over current 3A temperature rise is less than 25℃
L3	inductance is greater than 1mH, and the over current 10A temperature rise is less than 25℃

3. Remote control terminal (CNT) control method application recommendation

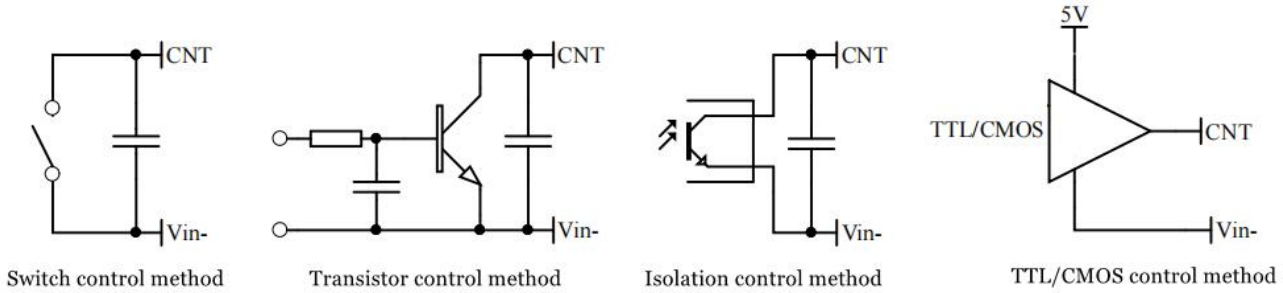

4. Sense usage and precautions

(1) Without far-end compensation:

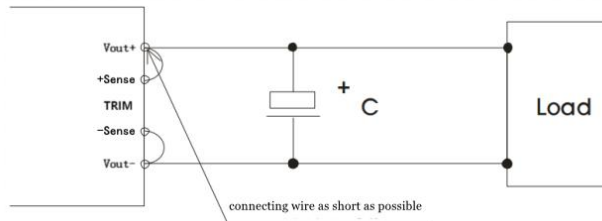

Precautions:

1. Do not use remote compensation, make sure Vout+ and Sense+, Vout- and Sense- are short-circuited;
2. The connection between Vout+ and Sense+, Vout- and Sense- should be as short as possible and close to the pins, otherwise the module may become unstable.

(2) Using remote compensation

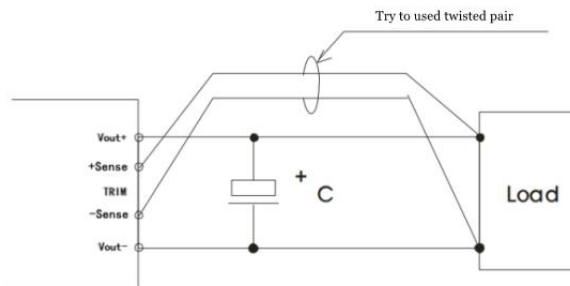

Precautions:

1. When the long-end compensation lead is used, the output voltage may be unstable;
2. If remote compensation is used, please use twisted pair or shielded wire, and keep the lead wire as short as possible;
3. Please use wide PCB leads or thick wires between the power module and the load, and keep the line voltage drop below 0.3V to ensure that the power output voltage remains within the specified range;
4. The impedance of the leads may cause the output voltage to oscillate or have larger ripples. Please verify it before use.

5. Use of TRIM and calculation of TRIM resistance

The relationship between output change voltage ΔU and resistance is as follows:

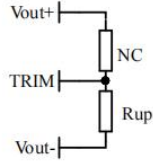

Voltage up regulation: add resistor R_{up} between Trim and output negative

$$R_{up} = 50 / \Delta U - 5.1 \text{ (K}\Omega\text{)}$$

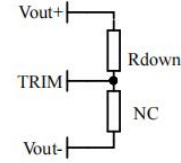

Voltage Down: Add resistor R_{down} between Trim and output positive

$$R_{down} = 20 * (28 - 2.5 * \Delta U) / \Delta U - 5.1 \text{ (K}\Omega\text{)}$$

6. This product does not support the use of direct parallel connection to increase the power. If you need to use it in parallel, please consult our technical staff.

Others

- 1 The warranty period of this product is two years. During the normal damage, it will be repaired free of charge. Damages caused by errors in the use method or manufacturing technology, a paid service is provided.
- 2 Our company can provide product customization and matching filter modules. For details, please contact our technical staff directly.

Guangzhou Aipu Electron Technology Co., Ltd

Address: Building 4, HEDY Park, No.63, Punan Road, Huangpu Dist, Guangzhou, China.

Tel: 86-20-84206763 Fax: 86-20-84206762 HOTLINE: 400-889-8821

E-mail: sales@aipu-elec.com Website: www.aipupower.com